















Unpacking

Before you begin using the device, please check the version you got and ensure that the following items are included in the shipped box:





Mainframe Accessories:

- | | | |
|--|---|---|
|  M3x5 screw x 4 |  ST1.7x4 screw x 2 |  M3x6 screw x 3 |
|  Allen Wrench x 1 |  Rope x 1 |  Rubber Plug x 3 |
|  Back cover x 1 |  Locking Cable Plate x 1 |  R29X x 1 |
|  Silicon rubber sealing ring x 1 | | |







Wall Mounting Accessories(Please find in On-wall Installation Kit box):

- | | | |
|---|--|---|
|  M4x30 screw x 2 |  ST4x20 screw x 6 |  Screw fixing seat x 6 |
|  wall-mounting box x 1 | | |

Flush Mounting Accessories(Please find in In-wall Installation Kit box):

- | | | |
|---|--|---|
|  M4x10 screw x 6 |  ST4x20 screw x 6 |  Screw fixing seat x 6 |
|  Flush-mounting bracket x 1 |  Embedded box x 1 | |

Plasterboard Mounting Accessories(Please find in Plasterboard Installation Kit box):

- | | | |
|---|--|--|
|  M4x30 screw x 4 |  Metal slider I x 2 |  Metal slider II x 2 |
|  Spring x 4 |  Flush-mounting bracket x 1 |  Decorative metal frame x 1 |

Product Overview

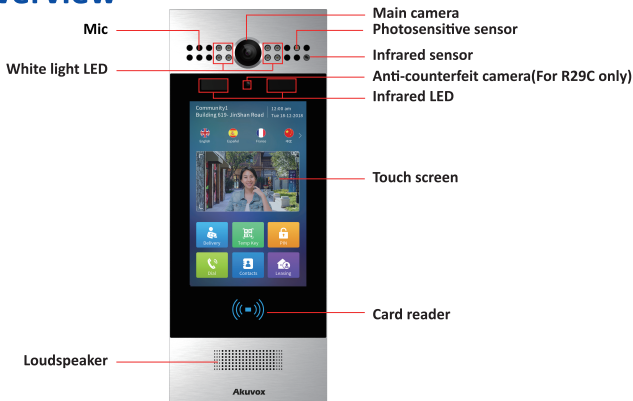

Installation

1. Step 1: Bracket/Box Installation

1.1 Wall Mounting

1.1.1 With 86 embedded box in the wall

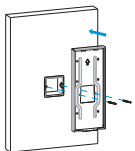

Fix the wall-mounting box on 86 embedded box with two M4x30 screws.

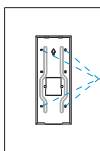

Mark the four holes of the wall-mounting box on the wall.

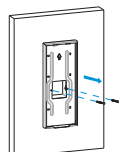

Take down two M4x30 screws and wall-mounting box.

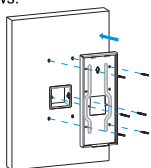

Fix the wall-mounting box with four ST4x20 screws and two M4x30 screws.

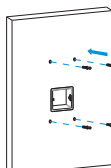

Insert the screw fixing seats into the holes.

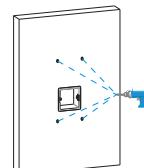

Use a hand drill with 5mm diameter bit to make holes in the marked positions.

1.1.2 Without 86 embedded box in the wall

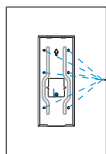

Mark the six holes of the wall-mounting box on the wall.

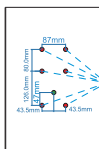

Use a hand drill with 5mm diameter bit to make the hole in marked positions.

*Please note the relative position in the left figure and the maximum error should less than 5mm.

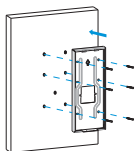

Fix the wall-mounting box with six ST4x20 screws.

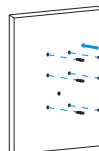

Insert the screw fixing seats into the holes you drilled before.

1.2 Flush Mounting

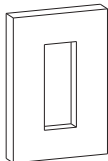

Dig out a square hole (height*width*depth=314*123*52 mm)
 Note: The size of the hole should be a little larger than recommended value that can accommodate all cables.

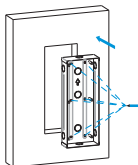

Insert the embedded box into the hole and make sure the cables of the device can route through the cable hole. Then mark the six holes of the wall embedded box on the wall.

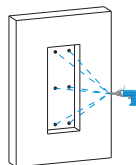

Take down the embedded box, then use a hand drill with 5mm diameter bit to make holes in the marked positions.

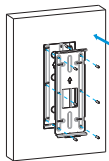

Use six M4x10 screws to fix the flush-mounting bracket on the embedded box.

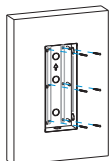

Place the embedded box into the square hole until the edges of which align to the wall and make all cables go through the cable hole. Fix the embedded box with six ST4x20 screws. Then use cement or non-corrosive structural adhesives to fill the gap between the wall and embedded box.

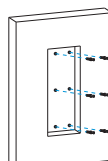

Insert the screw fixing seats into the hole you drill before.

Or you can choose another simple method without fixing ST4x20 screws.

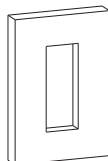

Dig out a square hole (height*width*depth=314*123*52 mm)
 Note: The size of the hole should be a little larger than recommended value that can accommodate all cables.

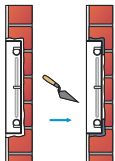

Use cement or non-corrosive structural adhesives to fill the gap between the wall and embedded box. Wait the adhesive material desiccation, go to the next step.

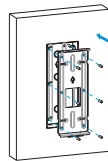

Use six M4x10 screws to fix the flush-mounting bracket on the embedded box.

1.3 Plasterboard Mounting

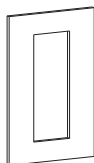

Dig through a square hole (height*width=311*117.5mm)
 Note: This mounting mode is only compatible with wall thickness of 1-25 mm.

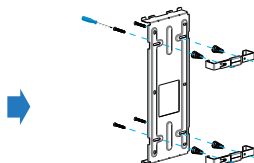

Follow the picture, using four M4x30 screws to fix the springs and sheet metals I & II. No need to completely tight the screws in this step.

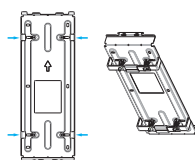

Follow the picture, close the sheet metals I & II.

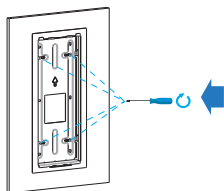

Fixing the four screws to tight the bracket.

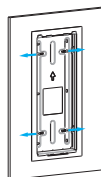

Toggle the screw outward to make the claw of the sheet metal insert the back of the wall.

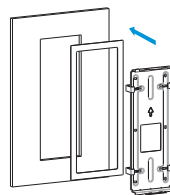

According to your need, attach the metal frame to the bracket.

2. Step 2: Back cover Installation

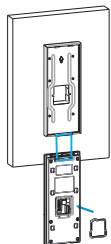

For convenient wiring, hang R29X on the wall-mounting box/ flush-mounting bracket with rope. Then insert the silicon rubber sealing ring into the groove.

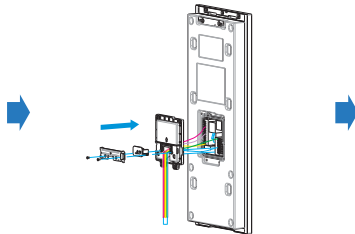

Make cables go through the back cover, connecting to the corresponding interfaces of the main board. Choose a suitable size rubber plug to compress cables, then fasten the locking cable plate with two ST1.7x4 screws.

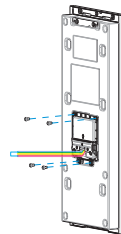

Use four M3x5 screws to fix the back cover.

3. Step 3: Device Mounting

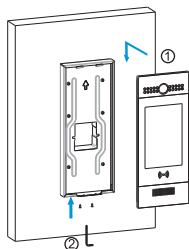

Wall Mounting

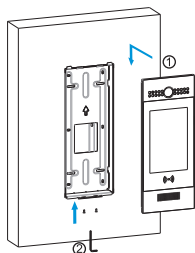

Flush Mounting & Plasterboard mounting

1. Place the device into the wall-mounting box / flush-mounting bracket until the edges of which align to the wall. Then pull the device downward and ensure the groove of it hooks to the lock catches of the back box.

2. Use the Allen wrench to tighten the device with two M3x6 screws.

Application Scenario

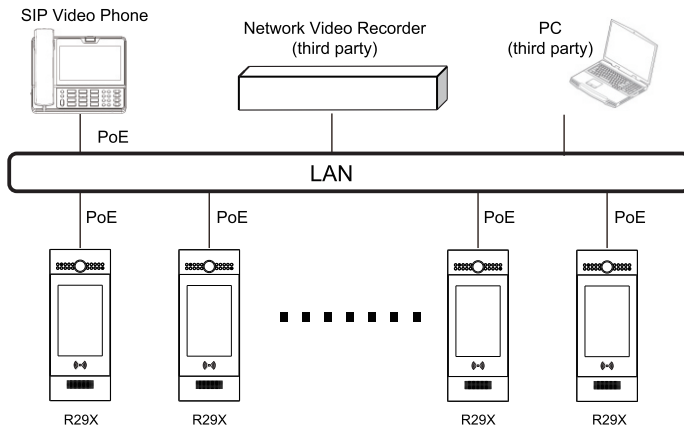

Configuration

- 1.IP Address Checking:Press 9999 in dialing interface, then input 3888 to enter the system interface. Click Info to check the IP address. R29X uses DHCP by default.
- 2.Account Registration:On web UI, go to the path: **Account -> Basic** page to register account and fill in the account information. (**Please refer to user manual for more information**)
- 3.DTMF Code Configuration:On web UI, go to the path: **Intercom -> Relay -> Relay ID/DTMF** choose the DTMF code number in corresponding area.

Operation

Make a call:

Input the room number, press Dial key to make a call.

Receive a call:

R29X supports Auto Answer by default. Incoming calls will be answered automatically.

Unlock by DTMF:

During the call, press the corresponding DTMF code from answer unit to unlock R29X remotely.

Unlock by Private Key:

In the PIN/PASSWORD interface, enter the password to open the door.

Unlock by RF Card:

Place the predefined RF Card in the RF reader area to open the door.

Notice Information



Information contained in this document is believed to be accurate and reliable at the time of printing. This document is subject to change without notice, any update to this document can be viewed on Akuvox's website: <http://www.akuvox.com> ©Copyright 2019 Akuvox Ltd. All rights reserved.

AKUVOX (XIAMEN) NETWORKS CO., LTD.

ADD: 10/F, NO.56 GUANRI ROAD, SOFTWARE PARK II, XIAMEN 361009, CHINA
www.akuvox.com



YS29000002